



UNDERCOUNTER DISHWASHER, 40 RACKS/H

Model: ELI1G36M

Article no: 502714

Power supply: 230V 1Ph ~60Hz

The new generation green&clean undercounter dishwashers are modern solutions designed for bars, cafès and small restaurants onboard. They are dedicated to customers that highly consider design and savings without compromising performance.

The dishwasher features low consumption in energy, water, detergent and rinse aid and the fully insulated double skin construction means less heat emission. The models excellent washing and rinsing performance are obtained by the double upper and lower washing and rinsing arms. Built-in pressure boiler sized to raise incoming 50°C water to guarantee a minimum rinsing temperature of 82 °C for sanitizing rinse. A fully automatic self-cleaning cycle avoids the risk of bacteria proliferation.

The machine is easy to use and keep constant monitoring, thanks to the visible temperature display. The display allows on-site personalization of washing and rinsing cycle times and temperatures and precise rinse aid and detergent quantities to suit your needs.

The unit has a safe and ergonomic counter-balanced door for soft opening and closing. There is no need to move the machine to perform maintenance thanks to the removable front panel.

MAIN FEATURES

- Pressure boiler
- Rinse water consumption only 2,5 litres/cycle
- Soft Start feature to offer additional protection to delicate items
- Double skinned insulated
- Low noise level
- Simple service from the front
- IPX4 water protection
- Pre-arrangement for HACCP

ELI1G36M, 502714

15-01-24 (14:26)

TECHNICAL DATA

ELI1G36M, 502714, 15-01-24 (14:26)

Model Number Specific	ELI1G36M
Voltage (V)	230
Phase	1
Frequency (Hz)	60
Loading (kW)	6,85
Fuse (A)	40
IP Class	X4
Capacity (racks/h)	40
Width, net (mm)	600
Depth, net (mm)	615
Height, net (mm)	820
Weight, net (kg)	68
Weight, gross (kg)	75
Volume, net (m3)	0,3
Volume, gross (m3)	0,5
Connection Cable, length (m)	1,5
Plug type	None
Atmospheric boiler	No
Certifications	CE, CB
Chlorides (mg/l)	20
Cold water inlet, diameter (")	3/4
Cycle time (s)	90
Detergent pump incl.	Yes
Dishwashing racks	1
Drain pipe, diameter (mm)	20
Drain pump	Yes
Hardness, max (dH°)	8
Hot water inlet temperature (°C)	50
Hot water inlet, diameter (")	3/4
Installation, type	Floor model
Noise level <(dB)	61
Rinse pump incl.	Yes
Rinse temperature (°C)	82
Temperature, max (°C)	65

Loipart AB (HQ), Sweden
Tel. +46 313 920 100, loipart@loipart.se

LMG Finland oy, Finland
+358 40 664 6680, lmg@lmg.fi



Loipart USA inc, USA
Tel. +1 954 530 5276, loipartusa@loipart.com

Loipart SEA Pte Ltd, Singapore
Tel. +65 674 99 100, contact@loipart.sg

Visit us at www.loipart.com

USPH	No
Water consumption (L/cycle)	2,5
Water pressure, max (Bar)	3
Water pressure, min (Bar)	2

INCLUDED IN DELIVERY

2 pcs of yellow cutlery container (864242) 1 pc of basket for 18 dinner plates - yellow (867002) 1 pc of basket for 48 small cups or 24 cups - blue (867007)

Loipart AB (HQ), **Sweden**
Tel. +46 313 920 100, loipart@loipart.se

LMG Finland oy, **Finland**
+358 40 664 6680, lmg@lmg.fi



Loipart USA inc, **USA**
Tel. +1 954 530 5276, loipartusa@loipart.com

Loipart SEA Pte Ltd, **Singapore**
Tel. +65 674 99 100, contact@loipart.sg

Visit us at www.loipart.com

DIMENSIONS

Model: ELI3G5M Rev. 1
 ELI3G6M
 ELI3G35M
 ELI1G36M

FRONT

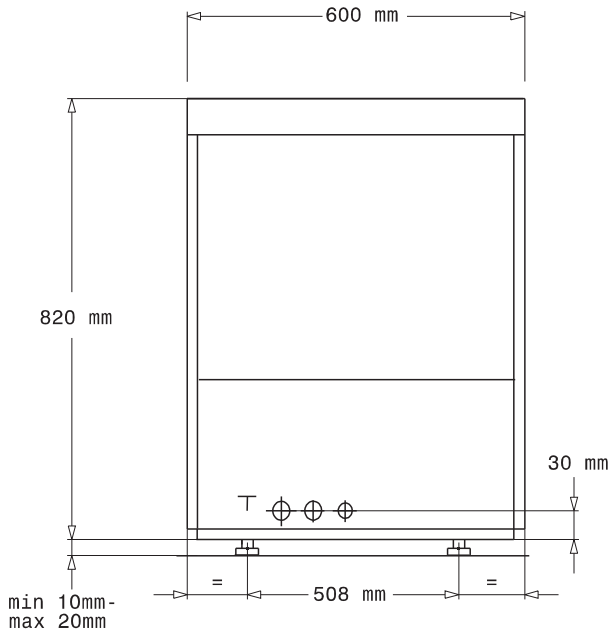

SIDE

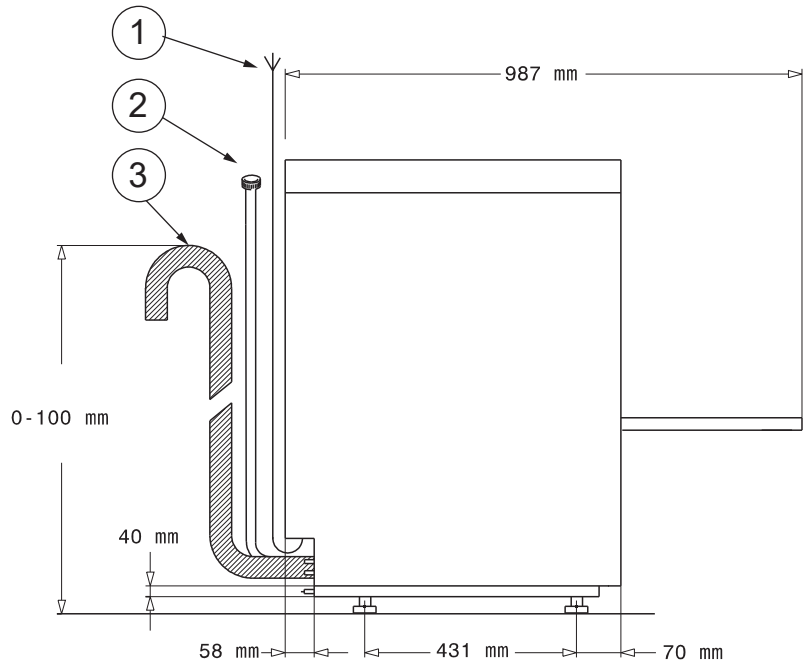

TOP

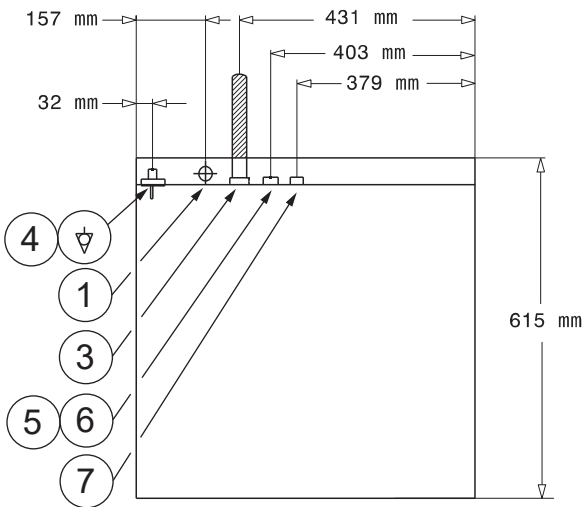

- 1. Electrical connection
- 2. Water inlet
- 3. Drain
- 4. Equipotential screw
- 5. Chemicals - detergent
- 6. Chemicals - rinse aid
- 7. Hot water inlet

DETAIL MARINE FOOT

