

WASHER-EXTRACTOR, MANUAL & AUTOMATIC DOSING 11 KG

Model: WN6-11

Article no: 9867730157

Power supply: 230V 1Ph ~50Hz

WN6 Electrolux washer-extractors has a certified ergonomic design with a human-centred approach for outstanding user experience. The washers are made with long term savings in mind and with very low water and energy consumption.

Compass Pro® microprocessor offers a large display and one control knob for easy program and language selection. There are also quick choice and option buttons for the most frequently used wash programs.

The normal spin washers have a high extraction force of 130G for efficient dewatering. They also have a Super Balance function that guarantees the correct extraction force is used to maximize water extraction, minimize vibration and lower maintenance and energy costs.

Washers are connectable to OnE Laundry, the personal assistant for hygiene validation, process management and revenue management. It's also possible to monitor the equipment and performance status from anywhere, allowing to take action to improve the business.

Global Advanced Hygiene program package with proven log 6 reduction disinfection of textiles through the laundry process, fulfilling the criteria of all locally approved standards.

MAIN FEATURES

- The Line 6000 series are the first washer/dryers to receive certification in ergonomic design
- Compass Pro® control system
- Super Balance function - optimized spin
- Extraction force 130G

WN6-11, 9867730157
15-01-24 (17:41)

Subject to change without notice
For correct installation, refer to the installation manual

Model Number Specific	WN6-11
Voltage (V)	230
Phase	1
Frequency (Hz)	50
Loading (kW)	7,9
Fuse (A)	35
IP Class	X4
Capacity (kg)	11
Capacity, filling factor	1:9
Capacity, filling factor (kg)	11
Capacity, water evaporation, max (L/h)	20
Width, net (mm)	720
Depth, net (mm)	700
Height, net (mm)	1220
Weight, net (kg)	152
Weight, gross (kg)	170
Volume, net (m3)	0,64
Volume, gross (m3)	0,83
Connection Cable, length (m)	0
Plug type	None
Certifications	CE
Cold water inlet, diameter (")	3/4
Detergent box	Top
Door Hanging	Right
Drain pipe, diameter (mm)	75
Drain pump	No
Drum type	Stainless steel
Energy consumption (kW/h)	1,9
Energy consumption, Normal, 60°C (kWh)	1,9
Exterior	Colored
G factor	130
Noise level <(dB)	68
Other general information	Water operated drain valve (normally opened).
Spin, max (rpm)	625

SS Front panel	Yes
Stackable	No
Volume, drum (L)	105
Water consumption, Normal, 60°C (L)	80
Water pressure, max (Bar)	8
Water pressure, min (Bar)	0,5

INCLUDED IN DELIVERY

Drain hose Ø 75mm L=440mm. Water hoses are available as accessories.

Loipart AB (HQ), **Sweden**
Tel. +46 313 920 100, loipart@loipart.se

LMG Finland oy, **Finland**
+358 40 664 6680, lmg@lmg.fi



Loipart USA inc. **USA**
Tel. +1 954 530 5276, loipartusa@loipart.com

Loipart SEA Pte Ltd, **Singapore**
Tel. +65 674 99 100, contact@loipart.sg

Visit us at www.loipart.com

DIMENSIONS

Model: WN6-8 Rev. 1
WN6-11
WN6-14
WN6-20
WN6-28

Marine installation

Install the machine close to a floor drain or open drain.
The machine should be positioned so that there is plenty of room for working, both for the user and service personnel. The figure shows minimum distance to a wall and/or other machines.

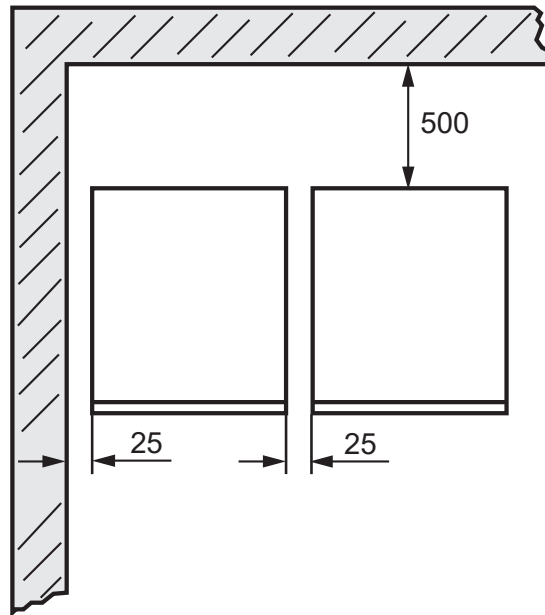

DIMENSIONS

Model: WN6-11 Rev. 1

FRONT

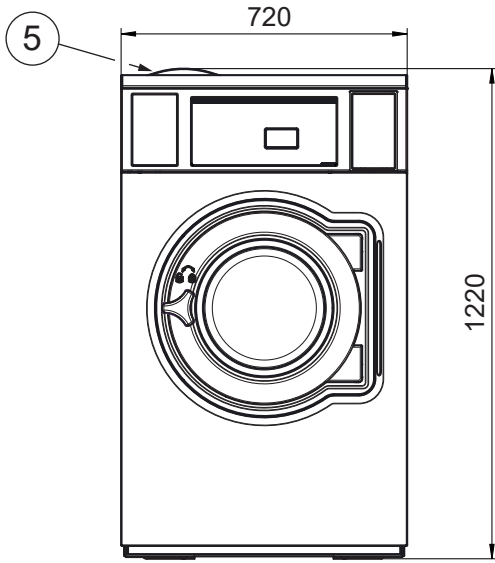

SIDE

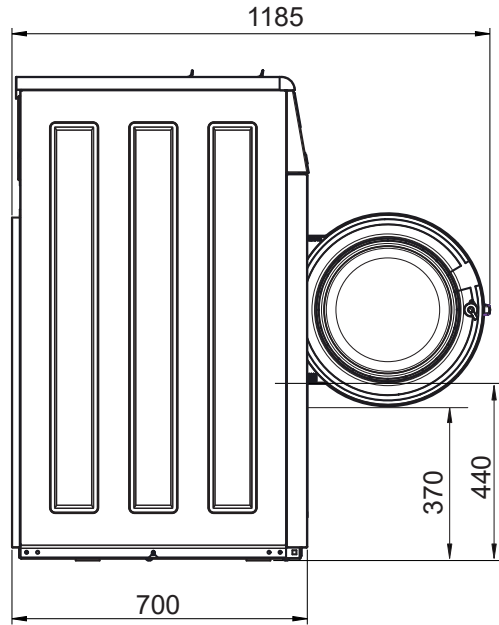

BACK

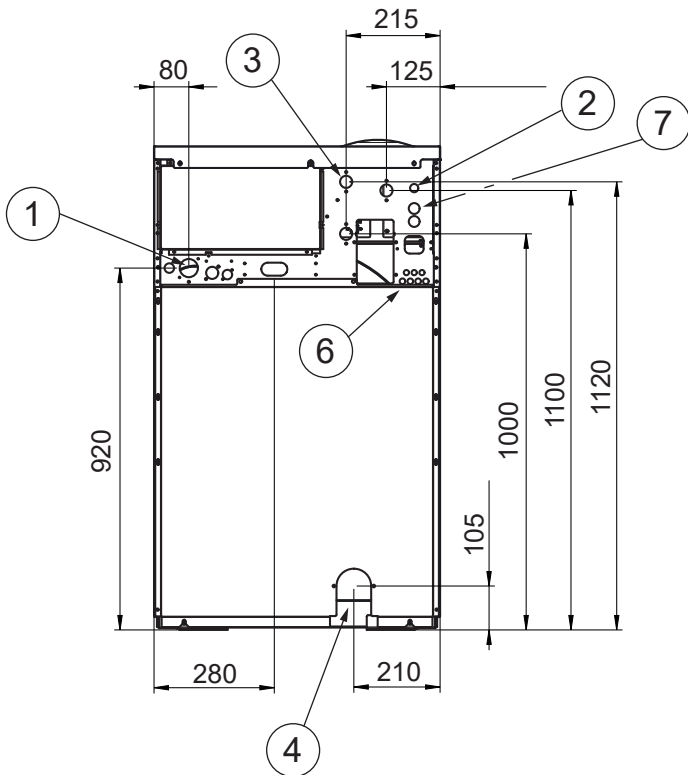

- 1. Electrical connection
- 2. Cold water connection
- 3. Hot water connection
- 4. Drain
- 5. Detergent container
- 6. Liquid detergent supply
- 7. Re-used water

Refer to the installation manual and the section "Marine installation" for instructions on how to secure the machine properly. Instructions are given for mechanical installation, welding a foundation or casting a plinth.

Mechanical installation

Foundation requirement

In this type of machine, the drum is attached directly to the frame. As a result the floor under the machine must be stable enough to absorb the dynamic forces generated during spin cycles. For that reason, the mounting bolts must be cast into the floor material itself.

When securing the machine to an existing concrete floor, it must be at least 200 mm thick, with a minimum concrete strength of 20.7 MPa. The floor must be free of seams and cracks.

If the floor is less than 200 mm, an alternative might be to cast a plinth. The floor must be able to withstand the loads indicated in the table in the Technical data section.

If an existing concrete floor (of 200 mm minimum thickness) is to serve as the foundation, but it is not possible to cast "J" bolts into the concrete, an alternative is to use so called chemical anchor bolts.

The machine must be securely fastened to a suitable foundation using 4-M16 threaded rod, heavy duty flat washers and lock nuts or lock washers. **For WN6-35: Also two M10 (3/8 inch) expansion bolts (1) MUST be installed at the front of the machine. If all six anchors are not properly installed, large vibrations in the machine's cabinet may occur.**

Failure to properly secure the machine to its foundation, or securing the machine to an inadequate foundation, will result in severe vibration, damage to the machine, and will void the manufacturer's warranty.

The following table shows the drilling points.

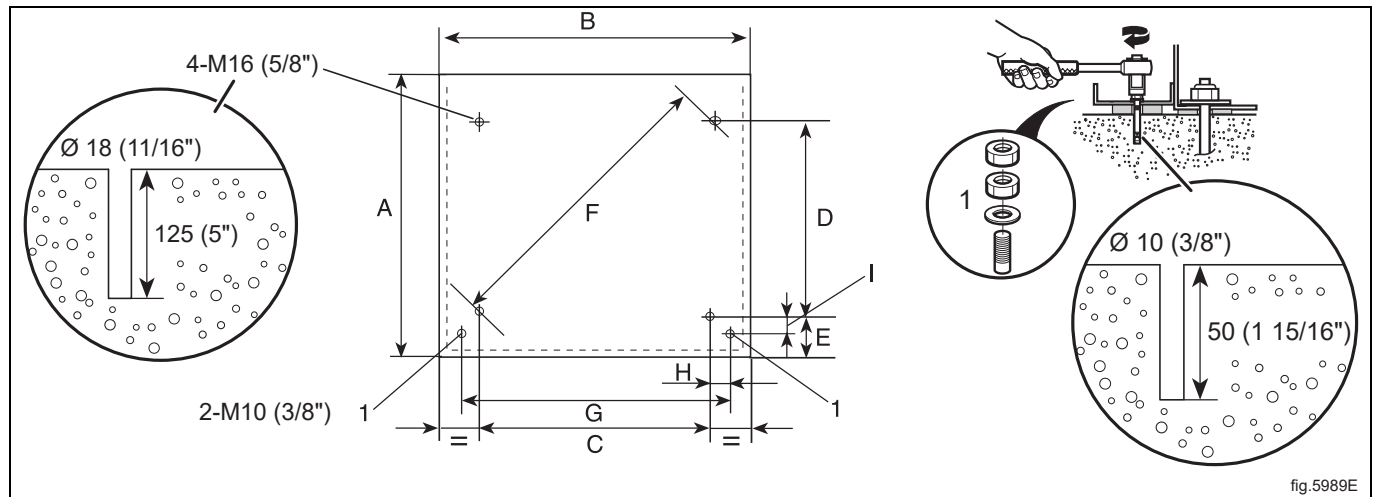

fig.5989E

mm	A	B	C	D	E	F	G	H	I
WN6-8	685	660	495	395	115	635	—	—	—
WN6-9	725	660	495	445	115	665	—	—	—
WN6-11	700	720	575	385	120	695	—	—	—
WN6-14	785	720	575	495	120	760	—	—	—
WN6-20	875	750	635	570	120	855	—	—	—
WN6-28	950	830	715	635	125	955	—	—	—
WN6-35	1035	910	790	695	135	1050	810	10	95

Mark and drill all holes for bolts in the positions shown.

Fix the thread rod M16 to the floor.