



BOILING PAN 60L

Model: EBE060

Article no: 9766920801

Power supply: 440V 3Ph ~50/60Hz

Electrolux boiling pans in the economy range are available in 4 sizes – 40, 60, 80 and 100 liters. The boiling pan is constructed in stainless steel, has motor tilting and a comfortable working height of 900 mm. It is well insulated and the outside temperature stays below 40°C. Installation can be made as twins, triples or larger. A measure stick is included in delivery. The right hand column/leg belongs to respective boiling pan. In this column/leg all technical parts are located such as control panel with continuous power control, pilot lamp, tilting motor with controls and other components.

MAIN FEATURES

- Hygienic Design
- Well Insulated
- Electric Tilting
- Economical
- All Technical Components in Right Column
- High Enclosure Class IPX5

EBE060, 9766920801

16-01-24 (17:21)

TECHNICAL DATA

EBE060, 9766920801, 16-01-24 (17:21)

Model Number Specific	EBE060
Voltage (V)	440
Phase	3
Frequency (Hz)	50/60
Loading (kW)	12,3
Max Amps in Phase (A)	16
Fuse (A)	25
IP Class	X5
Capacity (L)	60
Width, net (mm)	988
Depth, net (mm)	630
Height, net (mm)	900
Weight, net (kg)	100
Weight, gross (kg)	115
Volume, net (m3)	0,56
Volume, gross (m3)	0,73
Certifications	CE
Cold water inlet, diameter (")	1/2
Hardness, min (dH°)	0,5
Hardness, max (dH°)	3,5
Hot water inlet, diameter (")	1/2
Installation, type	Floor model
Noise level <(dB)	70
Pressure, max (Bar)	0,45
Temperature, max (°C)	118
Tilting, type	Electric
Time to boil (min)	30
Water pressure, max (Bar)	10

INCLUDED IN DELIVERY

1 measure stick

Loipart AB (HQ), Sweden
Tel. +46 313 920 100, loipart@loipart.se

LMG Finland oy, Finland
+358 40 664 6680, lmg@lmg.fi



Loipart USA inc, USA
Tel. +1 954 530 5276, loipartusa@loipart.com

Loipart SEA Pte Ltd, Singapore
Tel. +65 674 99 100, contact@loipart.sg

Visit us at www.loipart.com

8a. Left column prepared for mixing battery (optional extra) - installation:

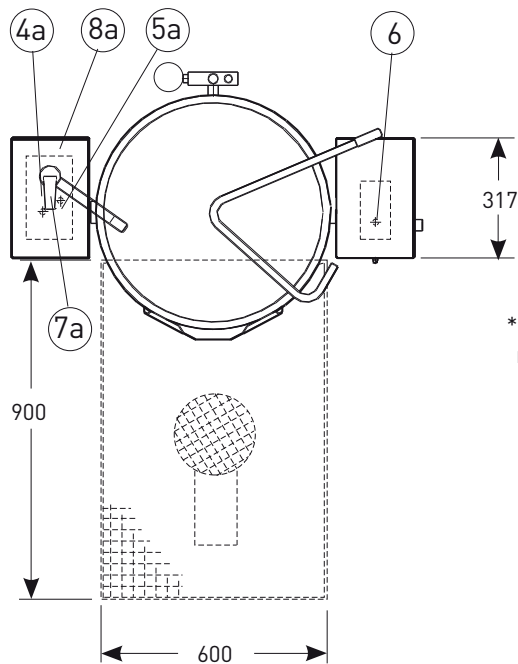

- 4a. Incoming HW feed, recommended conn. No 15*
- 5a. Incoming CW feed, recommended conn. No 15*
- 6. Electrical connection
- 7a. Mixing battery for hot and cold water, pipe outer diameter Ø10 mm
- 8a. Left column/leg prepared for mixing battery (see optional extras)

* Before connection to the mixing battery an on/off and non-return valve must be fitted on the incoming water feeds (not delivered by Loipart).

MARINE INSTALLATION

(RECOMMENDATIONS SINGLE PAN INSTALLATION)

The pan can either be bolted or welded to deck/foundation. We recommend that the foundation is raised at approx. 5-10 mm over the finished deck-covering to avoid penetration of water into the columns.

Example of installation of single boiling pan:

BOLTING: Level and position the boiling pan to be bolted to the deck. A fixture with pre-drilled holes is available as optional extra and necessary for locating the installation frames.

WELDING: Level and position the boiling pan and weld it to the deck. Installation frames can be used.

MULTIPLE STAND: Bolting as twins, triples etc requires additional installation frames for each column and one extra fixture for each boiling pan added. The fixture is necessary to mark out the exact position of the bolting holes for installation of the installation frames.

DIMENSIONS

Model: EBE060 Rev. 1

NOTE:

One left column/leg is required for every set of boiling pan or pans.

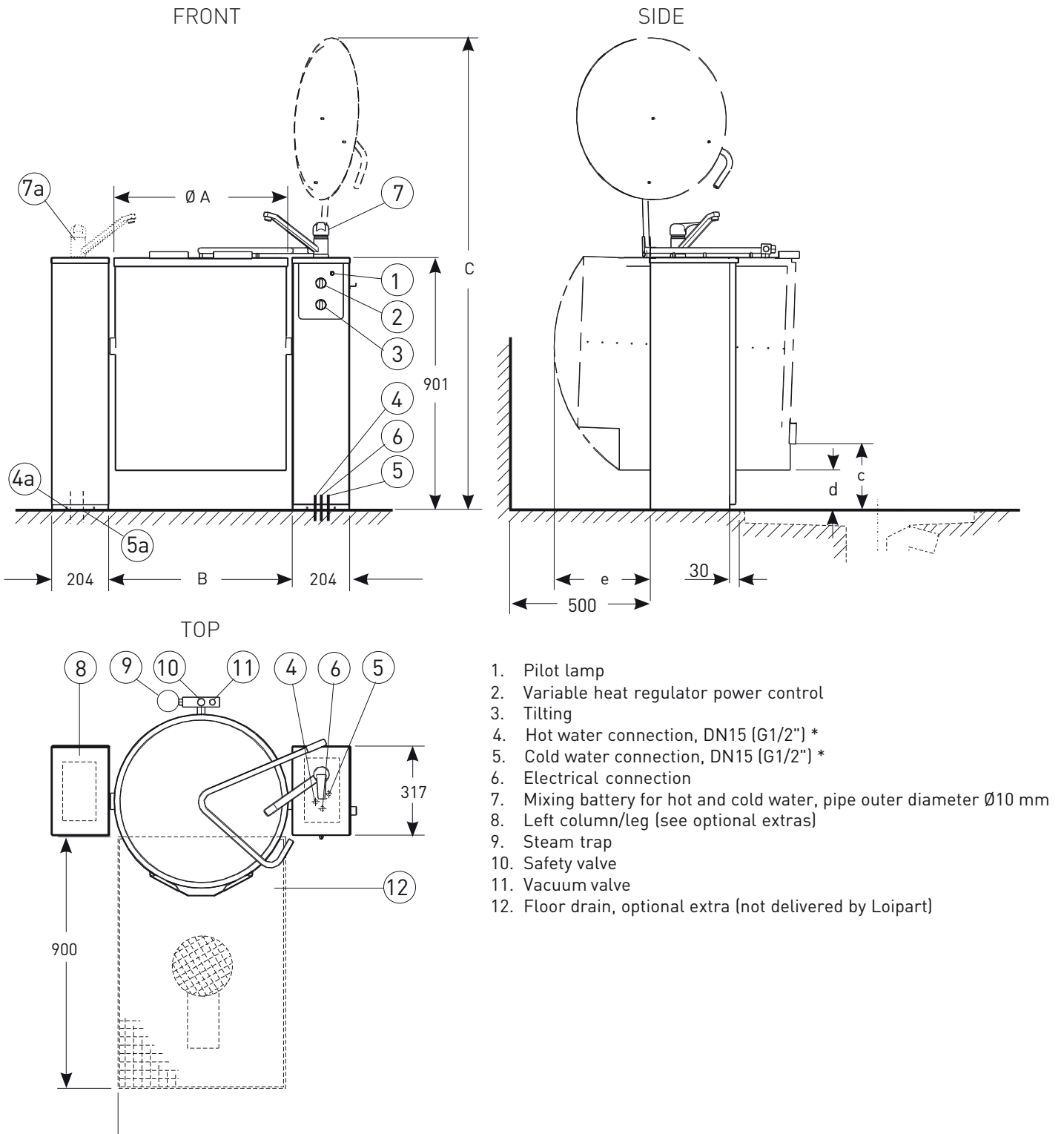

1. Pilot lamp
2. Variable heat regulator power control
3. Tilting
4. Hot water connection, DN15 (G1/2") *
5. Cold water connection, DN15 (G1/2") *
6. Electrical connection
7. Mixing battery for hot and cold water, pipe outer diameter $\varnothing 10$ mm
8. Left column/leg (see optional extras)
9. Steam trap
10. Safety valve
11. Vacuum valve
12. Floor drain, optional extra (not delivered by Loipart)

Dimensions (mm)

A	B	C	c	d	e
540	580	1620	280	155	320